

Gardner Denver

QUANTIMA Q43/Q52/70L | 300-400 HP
OIL-LESS TWO STAGE VARIABLE SPEED CENTRIFUGAL COMPRESSOR

Quantima[®] Series



ZERO RISK

of Contamination

Because Quantima features an Oil Less design there is no oil used anywhere inside the machine which ensures there is Zero Risk of product contamination due to oil carryover. The Quantima meets ISO 8573-1 Class 0, the most stringent class. It is also certified Silicone Free which is critical for applications such as automotive and pharmaceutical.

CLASS	CONCENTRATION TOTAL OIL (AEROSOL, LIQUID, VAPOR) MG/M ³
0	As specified by the equipment user or supplier and more stringent than class 1
1	≤ 0.01
2	≤ 0.1
3	≤ 1
4	≤ 5

Silicone-Free

Silicone contamination in compressed air systems cause problems across a wide range of industries such as electronics, pharmaceuticals and automotive. Costly product spoilage, re-work and production downtime can result from this contamination.

For example, a high quality paint finish is essential to the automotive industry. Blisters, cracking, craters and a loss of adhesion are all symptoms of silicone contamination.

- 100% silicone-free, guaranteed
- Specifically designed for use in pure-air critical applications such as the automotive industry
- Avoids contamination and provides the highest air quality standards
- Independently tested and certified



PureAir

ISO CLASS: ZERO PLUS SILICONE FREE

Unprecedented Energy Savings

The two-stage variable speed centrifugal Quantima provides unmatched efficiency due to its low level of energy consumption and its incredibly low off load power consumption. At 400 HP, the Quantima off-load power is 2.5% of full load power or 7.5 kW while comparable compressors have an off load power of 15 to 70% of their full load power.

These off load power savings, along with better efficiency result in up to 25% lower energy consumption when compared to a two-stage variable speed oil-free rotary screw compressor. This lower energy consumption can translate into annual energy savings of \$10,000/year or more.

Lowest Energy across the entire flow range

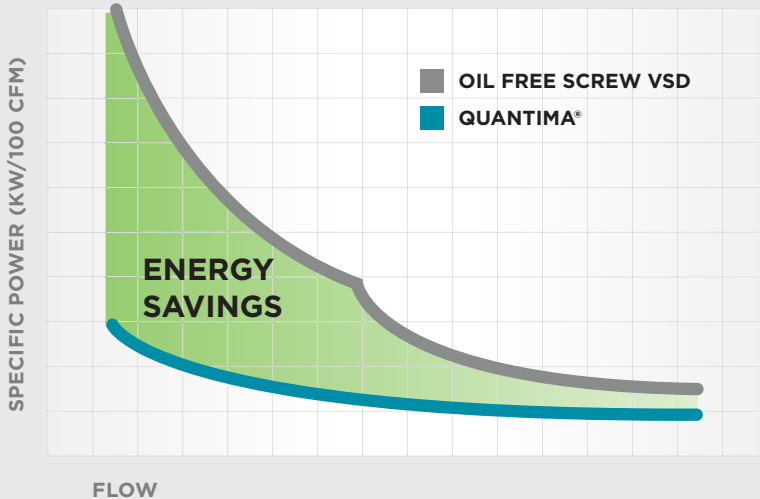

- Variable speed technology efficiently matches output to requirement minimizing off-load running
- Industry- leading efficiency due to no gearbox and no contact parts
- Energy savings of up to 25% and more are easily achievable



No Performance Degradation over life of compressor unlike standard screw technologies with wearing parts

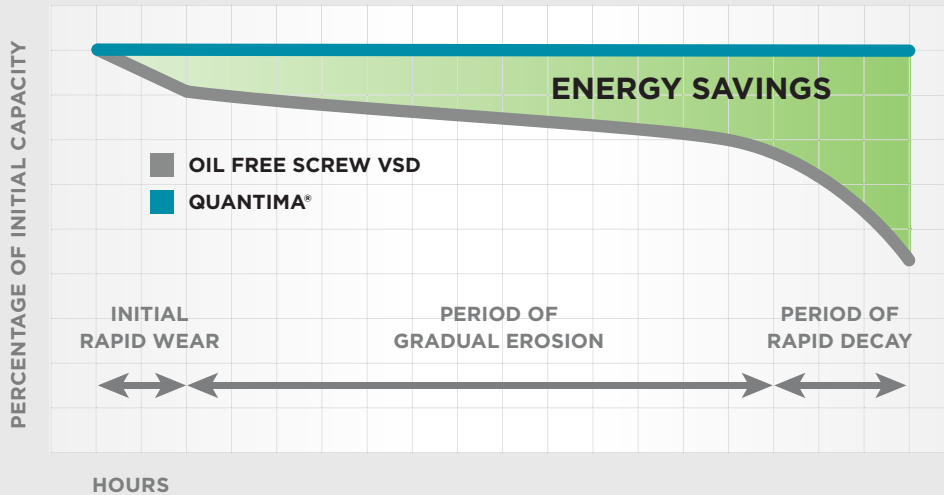

- No airend coating to wear off causing reduced performance
- No contacting parts
- Maintains efficiency over time
- No airend element replacement needed to maintain performance

Reduced Maintenance Cost

The design of the Quantima features only one rotating part suspended in air by a magnetic field. There are no rotor timing gears, no gearbox to drive the compression stages and therefore no oil required for lubrication. As a result, there is no oil or oil filter to replace and dispose, providing significant savings on maintenance costs.

With standard rotary dry screw technologies the airend elements have a limited life span and will lose performance over time and may require replacement in as little as 40,000 hours of operation. For a plant that operates 24/7 that can occur in just 6 years! The elements can cost upwards of \$50,000 not to mention the labor and downtime to install them.

Quantima does not lose performance over time, and will not require an element change to maintain efficiency. This translates into **savings of up to 25%** on maintenance costs.

Footprint Savings

Simple Installation—the Quantima compressor is only a fraction of the weight and size of equivalent conventional dry screw compressors and therefore features a smaller footprint.

- Lower installation costs
- Increased flexibility when determining installation location



FOOTPRINT COMPARISON

- Standard 400 HP Screw Package
- Q52 Quantima Package

WITHOUT SACRIFICING SERVICEABILITY,
QUANTIMA PACKAGES FEATURE
THE **SMALLEST FOOTPRINT** IN THE INDUSTRY.



GARDNER
DENVER—TAKING
QUIET
TO A WHOLE
NEW LEVEL

Lowest Sound Levels

The Gardner Denver Quantima Series compressor designs feature high-quality, sound-insulating enclosure panels and a vibration-free design. These features reduce the sound levels and eliminate the need for a separate compressor room, saving money on installation costs and providing installation location flexibility.

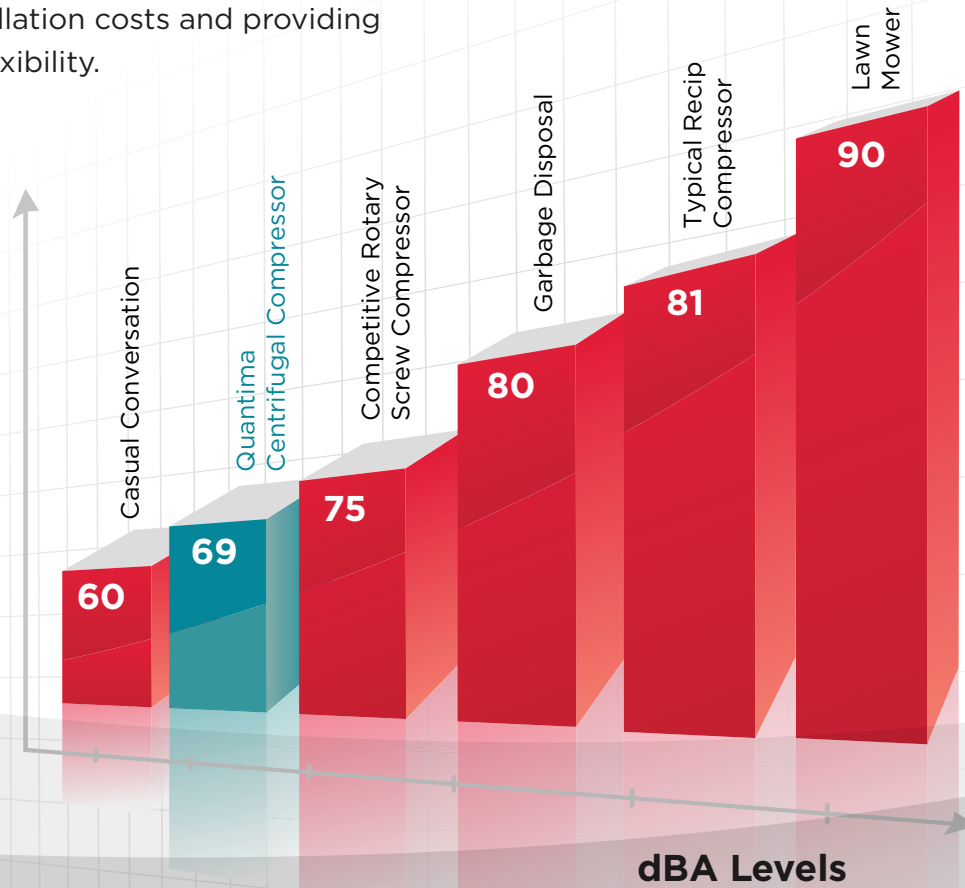

Gardner Denver
QUANTIMA

LOWEST

TOTAL COST

OF OWNERSHIP

\$10,000

per year or more in

Annual Energy

SAVINGS*

SMALLEST

Footprint

*Less than standard screw technologies

25%
LOWER
Maintenance
Cost

ZERO
RISK
of
Contamination

QUIET
69 dBA
6 dBA lower than
competitive units



Less is More

Equipped with the patented Q-drive compression and motor assembly, the Quantima has just one moving part and operates with the rotor spinning in a magnetic field at up to 76,000 rpm. The unique design eliminates the need for a gearbox and oil, while also ensuring that no contact or wear occurs.



Quantima

Standard Screw Technology

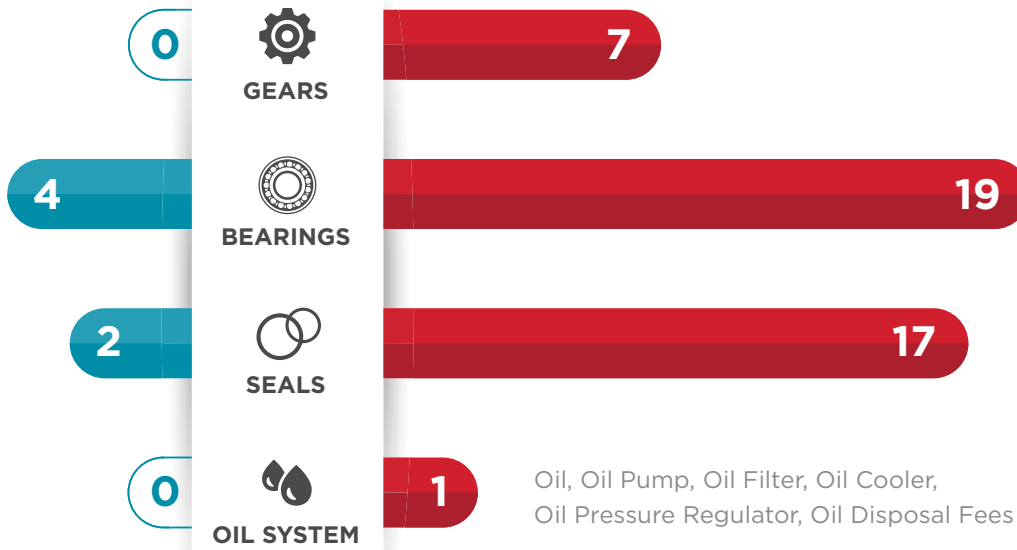

FEWER PARTS =

Unparalleled Reliability + Peace of Mind

Ultimate Reliability

The Quantima not only provides unmatched efficiency, but its design ensures that it's one of the most robust and reliable compressors on the market. Gardner Denver's focus on developing compressors that feature superior reliability is demonstrated in the design of the high speed unit. The high speed unit (HSU) is the heart of this centrifugal compressor and consists of low- and high-pressure stages directly driven by a robust high-speed motor. The low pressure stage of the features a **titanium*** impeller for greater strength, increased reliability and extended replacement intervals.

THE QUANTIMA DELIVERS
UNMATCHED **EFFICIENCY**, PREMIUM **RELIABILITY**
AND THE LOWEST ENVIRONMENTAL IMPACT.

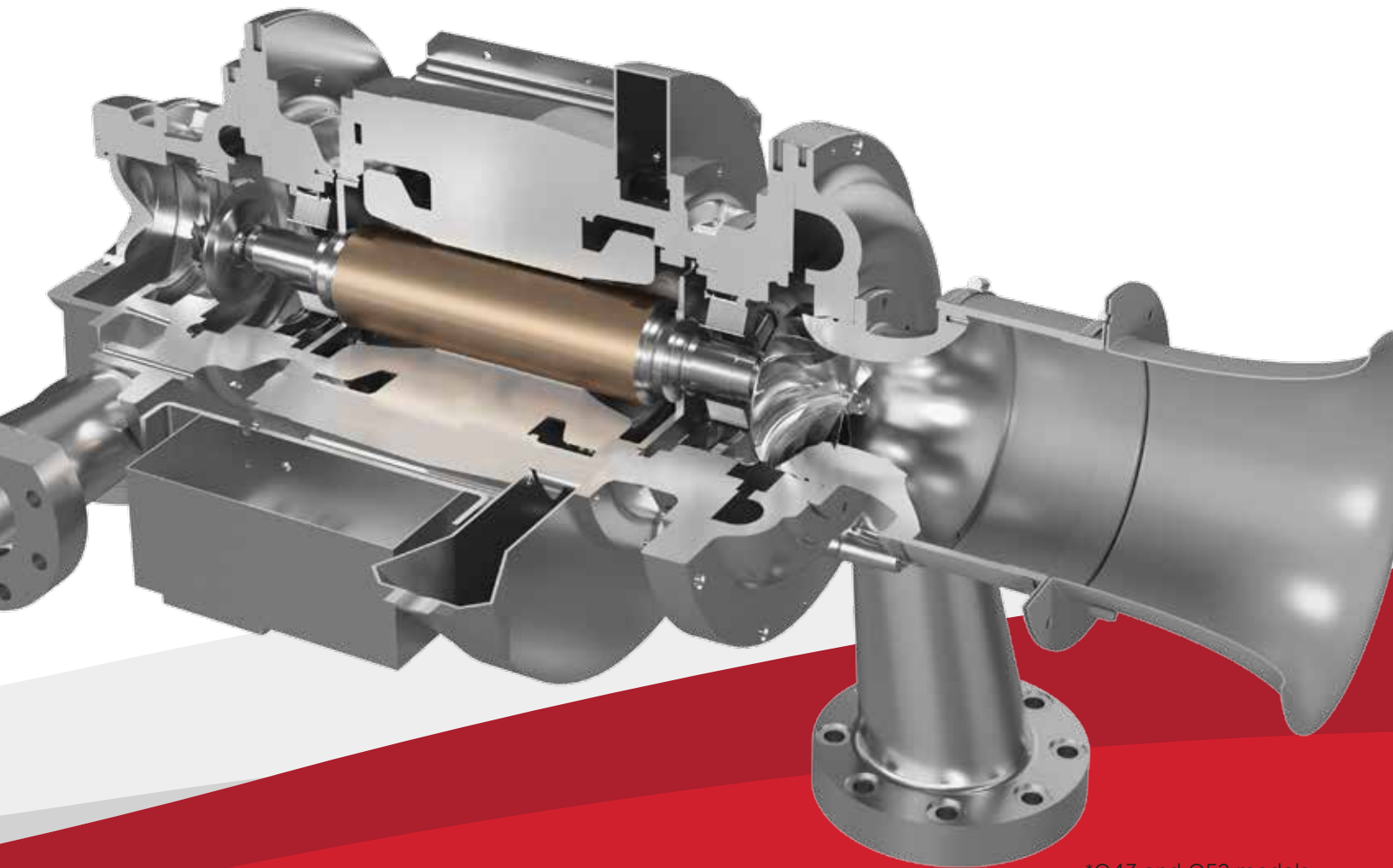

*Q43 and Q52 models.

Never Out of Control

Gardner Denver Quantima compressors feature the Q-master™ controller. The Q-master provides comprehensive control and protection of the compressor's operation. It incorporates a touch screen panel as well as intuitive navigation and an easy-to-use menu structure. It also includes sophisticated control methodology, optional remote monitoring capabilities and surge calibration, which is designed to minimize energy consumption.





- 7.7" Color Touch Screen
- Adjust all compressor settings
- View temperatures & pressures
- Automatic data logging
- Fault logging & diagnostics
- Remote monitoring via customer LAN ethernet connection
- Remote control by Modbus RTU via RS485 or direct hardware input

Keeping the System **Healthy**

Experience Peace of Mind

Gardner Denver's engineering philosophy ensures long-lasting, reliable equipment. Our simple, but bold warranty programs demonstrate our belief in the quality found in Gardner Denver compressors.

Total System Protection

Since 1859, Gardner Denver has been supporting the compressed air industry with high quality, long-lasting compressor and air treatment solutions. Carrying on that legacy, our robust line of parts and downstream accessories ensure your system stays healthy.

Gardner Denver's focus on total system protection not only includes OEM parts, but a commitment to the longevity of your equipment through our industry leading warranty programs.

Protect your investment.

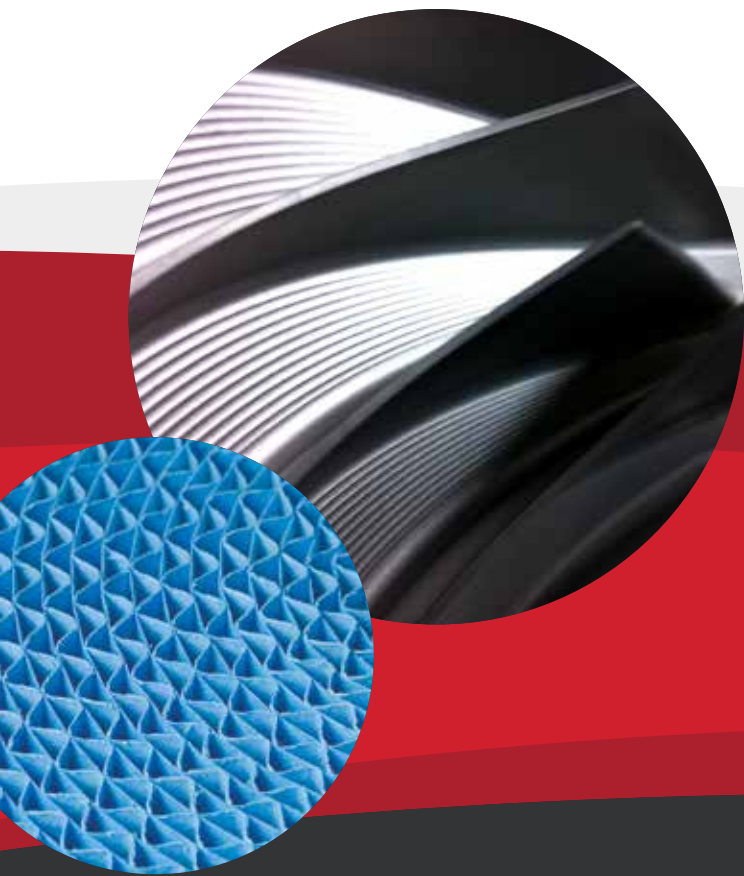

Sales & Service **Distributors**

An Extensive Network Across America

By leveraging the extensive network of Gardner Denver factory-trained authorized local distributors, your sales, service and technical support needs can be handled quickly and easily.

To find a distributor visit:
gardnerdenver.com/GDproducts

Specifications

MODEL	DRIVE MOTOR		MAXIMUM PRESSURE		FAD @ 100 PSIG**		NOISE LEVEL	WEIGHT		DIMENSIONS L x W x H IN. (MM)
	HP	KW	PSIG	BAR	ACFM	M ³ /MIN	DB(A)	LBS	KG	
Q43*	320	240	116	8	1530	43.3	69	5732	2600	95 x 63 x 73 (2400 x 1600 x 1850)
Q52*	400	300	116	8	1762	49.9	69	5732	2600	

MODEL	DRIVE MOTOR		MAXIMUM PRESSURE		FAD @ 73 PSIG**		NOISE LEVEL	WEIGHT		DIMENSIONS L x W x H IN. (MM)
	HP	KW	PSIG	BAR	ACFM	M ³ /MIN	DB(A)	LBS	KG	
Q70L	400	300	73	5	2309	65.4	69	8376	3800	116 x 79 x 77 (2950 x 2000 x 1950)

*First stage titanium impeller.

**Data measured in accordance with ISO1217 Annex C at the following conditions: Air Intake Pressure: 1 bar a / 14.5 psia; Air Intake Temperature: 20° C / 68° F; Humidity: 0% (dry)



The leader in every market we serve
by continuously improving all business processes
with a focus on innovation and velocity

**Gardner
Denver**[®]

Gardner Denver, Inc.

1800 Gardner Expressway
Quincy, IL 62305
866-242-1636

www.gardnerdenver.com/gdproducts



©2017 Gardner Denver, Inc. Printed in U.S.A.
GDQ-Q43-Q70L 1st Ed. 10/17
Supersedes GDQ-Q26-Q70L 1st Ed. 9/16

 Please recycle after use.